

## 4020 LUMINY 2

«Medium» version in the Luminy spotlight range.

Installs on roads/floors, wall or poles with custom-adaptable accessories.

### APPLICATIONS:

- Highlight architectural features
- Highlight landscapes
- Path lighting, lanes, street furniture
- Colourless anodised machined aluminium body
- Vandalproof organic glass window
- 316L Stainless steel bracket and screws
- Thermolacquered bracket on request
- RGBW options available

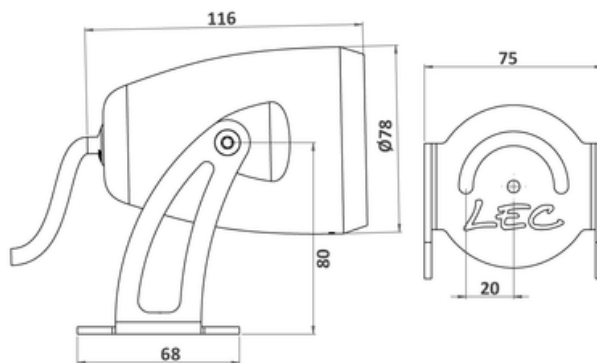

### AVAILABLE OPTIONS

Number of LEDs	4
Type of LEDs	Power LEDs. Contact us for hot countries.

Select your specific requirements with our product configurator, by filtering technical criteria at the following link:  
<http://www.lec-lyon.com/4020-luminy-2-r137>

### APPLICATION

#### Outdoor lighting

Standard flux : **892 lm**

*This value is gained from the optimum output of the LED number, inclusive of optic, for a cool white LED (6000K)*

### MOUNTING TYPE

- Wall lights
- Masts

### CARACTERISTICS

Weight : **750 g**

### Options of luminous effects

- RGBW option
- Adjustable on 2 axis
- Rotating beam
- Beam with various openings
- Transparent flat window
- Colour control system (optional)

### Power supply - Control

Cable length: **1 m**

### Material

- AL Anodised glazed aluminium
- PC2 Vandalism-proof, scratch-proof, UV-proof, polycarbonate window, M2

### Mechanical strength - Waterproofness

- IK10 Resists impacts up to 20 joules (IK10)
- IP67 Tight for temporary immersion

## 4020 LUMINY 2

This datasheet gives you all the available optics for this product, consistent with the number of LEDs.

URL of this product: <http://www.lec-lyon.com/4020-luminy-2-r137>

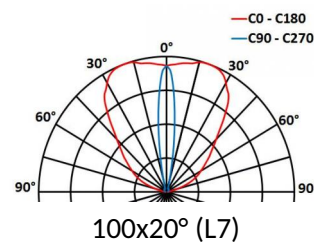
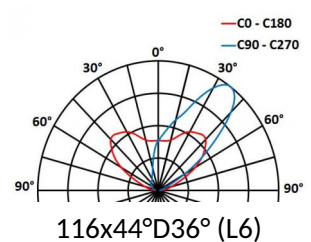
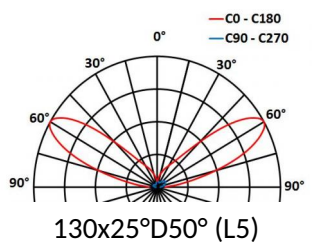
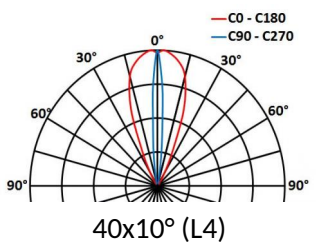
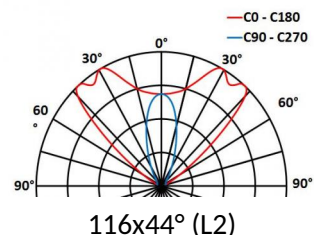
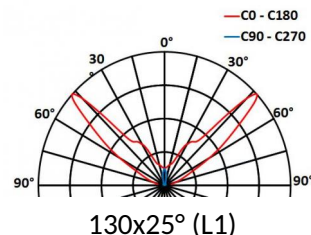
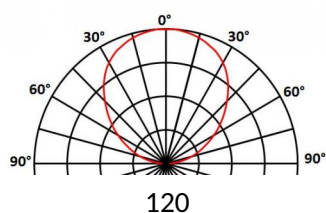
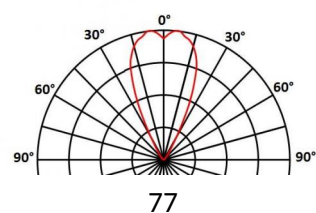
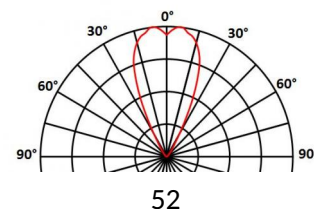
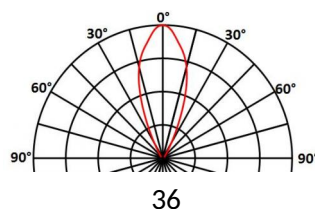
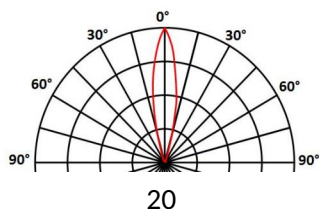
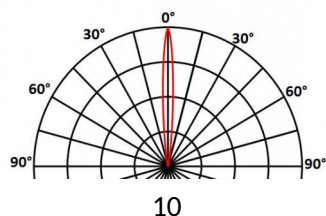

Sur mesure On request

